

**PI734G** - Technical Data Sheet

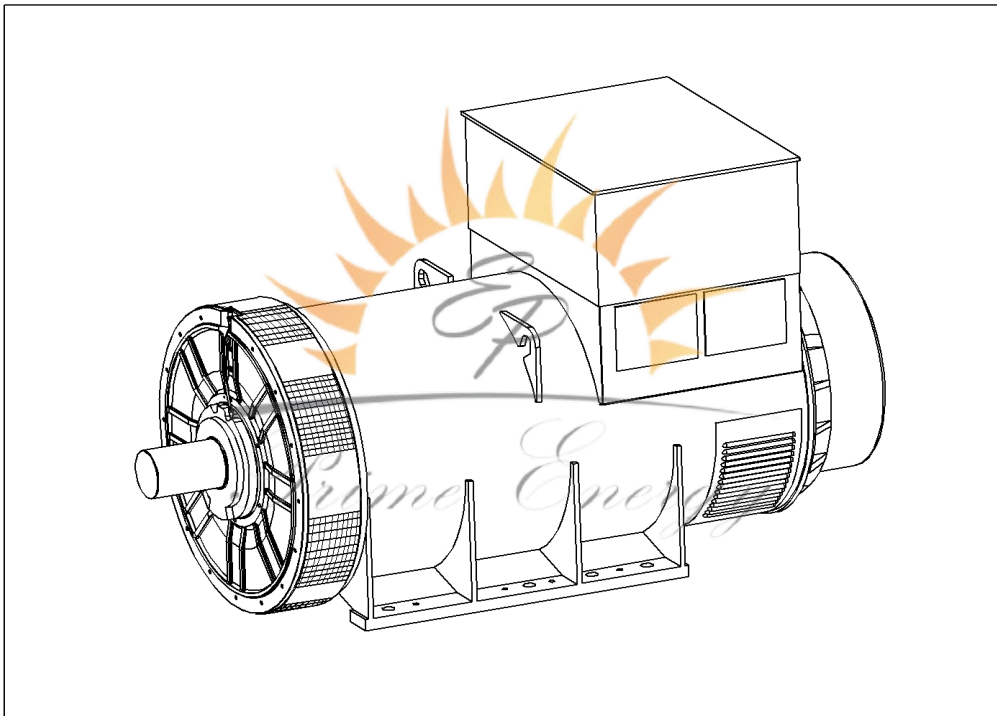

# PI734G

## SPECIFICATIONS & OPTIONS



### STANDARDS

Newage Stamford industrial generators meet the requirements of BS EN 60034 and the relevant sections of other national and international standards such as BS5000, VDE 0530, NEMA MG1-32, IEC60034, CSA C22.2-100, AS1359.

Other standards and certifications can be considered on request.

### DESCRIPTION

The STAMFORD PI range of synchronous ac generators are brushless with a rotating field. They are separately excited by the STAMFORD Permanent Magnet Generator (PMG). This is a shaft mounted, high frequency, pilot exciter which provides a constant supply of clean power via the Automatic Voltage Regulator (AVR) to the main exciter. The main exciter output is fed to the main rotor, through a full wave bridge rectifier, protected by surge suppression.

### VOLTAGE REGULATORS

The PI range generators, complete with a PMG, are available with one of two AVRs. Each AVR has soft start voltage build up and built in protection against sustained over-excitation, which will de-excite the generator after a minimum of 8 seconds.

Underspeed protection (UFRO) is also provided on both AVRs. The UFRO will reduce the generator output voltage proportional to the speed of the generator below a pre-settable level.

The **MX341 AVR** is two phase sensed with a voltage regulation of  $\pm 1\%$ . (see the note on regulation).

The **MX321 AVR** is 3 phase rms sensed with a voltage regulation of 0.5% rms (see the note on regulation). The UFRO circuit has adjustable slope and dwell for controlled recovery from step loads. An over voltage protection circuit will shutdown the output device of the AVR, it can also trip an optional excitation circuit breaker if required. As an option, short circuit current limiting is available with the addition of current transformers.

Both the MX341 and the MX321 need a generator mounted current transformer to provide quadrature droop characteristics for load sharing during parallel operation. Provision is also made for the connection of the STAMFORD power factor controller, for embedded applications, and a remote voltage trimmer.

### WINDINGS & ELECTRICAL PERFORMANCE

All generator stators are wound to 2/3 pitch. This eliminates triplen (3rd, 9th, 15th ...) harmonics on the voltage waveform and is found to be the optimum design for trouble-free supply of non-linear loads. The 2/3 pitch design avoids excessive neutral currents sometimes seen with higher winding pitches. A fully connected damper winding reduces oscillations during paralleling. This winding, with the 2/3 pitch and carefully selected pole and tooth designs, ensures very low levels of voltage waveform distortion.

### TERMINALS & TERMINAL BOX

Standard generators feature a main stator with 6 ends brought out to the terminals, which are mounted on the frame at the non-drive end of the generator. A sheet steel terminal box contains the AVR and provides ample space for the customers' wiring and gland arrangements. It has removable panels for easy access.

### SHAFT & KEYS

All generator rotors are dynamically balanced to better than BS6861:Part 1 Grade 2.5 for minimum vibration in operation. Two bearing generators are balanced with a half key.

### INSULATION/IMPREGNATION

The insulation system is class 'H', and meets the requirements of UL1446.

All wound components are impregnated with materials and processes designed specifically to provide the high build required for static windings and the high mechanical strength required for rotating components.

### QUALITY ASSURANCE

Generators are manufactured using production procedures having a quality assurance level to BS EN ISO 9001.

### NOTE ON REGULATION

The stated voltage regulation may not be maintained in the presence of certain radio transmitted signals. Any change in performance will fall within the limits of Criteria 'B' of EN 61000-6-2:2001. At no time will the steady-state voltage regulation exceed 2%.

Note: Continuous development of our products entitles us to change specification details without notice, therefore they must not be regarded as binding.

Front cover drawing is typical of the product range.

**PI734G**  
**WINDING 312**

CONTROL SYSTEM	SEPARATELY EXCITED BY P.M.G.		
A.V.R.	MX341	MX321	
VOLTAGE REGULATION	± 1%	± 0.5 %	With 4% ENGINE GOVERNING
SUSTAINED SHORT CIRCUIT	REFER TO SHORT CIRCUIT DECREMENT CURVES (page 7)		

INSULATION SYSTEM	CLASS H							
PROTECTION	IP23							
RATED POWER FACTOR	0.8							
STATOR WINDING	DOUBLE LAYER LAP							
WINDING PITCH	TWO THIRDS							
WINDING LEADS	6							
MAIN STATOR RESISTANCE	0.0008 Ohms PER PHASE AT 22°C STAR CONNECTED							
MAIN ROTOR RESISTANCE	2.42 Ohms at 22°C							
EXCITER STATOR RESISTANCE	16 Ohms at 22°C							
EXCITER ROTOR RESISTANCE	0.043 Ohms PER PHASE AT 22°C							
R.F.I. SUPPRESSION	BS EN 61000-6-2 & BS EN 61000-6-4, VDE 0875G, VDE 0875N. refer to factory for others							
WAVEFORM DISTORTION	NO LOAD < 1.5% NON-DISTORTING BALANCED LINEAR LOAD < 5.0%							
MAXIMUM OVERSPEED	2250 Rev/Min							
BEARING DRIVE END	BALL. 6232 C3							
BEARING NON-DRIVE END	BALL. 6319 C3							
	1 BEARING				2 BEARING			
WEIGHT COMP. GENERATOR	4054 kg				4022 kg			
WEIGHT WOUND STATOR	2015 kg				2015 kg			
WEIGHT WOUND ROTOR	1697 kg				1654 kg			
WR <sup>2</sup> INERTIA	52.2511 kgm <sup>2</sup>				51.3341 kgm <sup>2</sup>			
SHIPPING WEIGHTS in a crate	4127kg				4091kg			
PACKING CRATE SIZE	216 x 105 x 154(cm)				216 x 105 x 154(cm)			
	50 Hz				60 Hz			
TELEPHONE INTERFERENCE	THF<2%				TIF<50			
COOLING AIR	2.69 m <sup>3</sup> /sec 5700 cfm				3.45 m <sup>3</sup> /sec 7300 cfm			
VOLTAGE STAR	380/220	400/231	415/240	440/254	416/240	440/254	460/266	480/277
KVA BASE RATING FOR REACTANCE VALUES	2135	2200	2200	2160	2475	2640	2695	2750
X <sub>d</sub> DIR. AXIS SYNCHRONOUS	3.71	3.45	3.20	2.80	4.48	4.27	3.99	3.74
X' <sub>d</sub> DIR. AXIS TRANSIENT	0.21	0.19	0.18	0.15	0.25	0.24	0.22	0.21
X'' <sub>d</sub> DIR. AXIS SUBTRANSIENT	0.15	0.14	0.13	0.11	0.18	0.17	0.16	0.15
X <sub>q</sub> QUAD. AXIS REACTANCE	2.38	2.22	2.06	1.80	2.88	2.75	2.57	2.41
X'' <sub>q</sub> QUAD. AXIS SUBTRANSIENT	0.28	0.26	0.24	0.21	0.34	0.32	0.30	0.28
X <sub>L</sub> LEAKAGE REACTANCE	0.03	0.03	0.03	0.03	0.04	0.04	0.04	0.04
X <sub>2</sub> NEGATIVE SEQUENCE	0.20	0.19	0.18	0.15	0.25	0.23	0.22	0.21
X <sub>0</sub> ZERO SEQUENCE	0.04	0.04	0.03	0.03	0.05	0.04	0.04	0.04
REACTANCES ARE SATURATED				VALUES ARE PER UNIT AT RATING AND VOLTAGE INDICATED				
T' <sub>d</sub> TRANSIENT TIME CONST.	0.16s							
T'' <sub>d</sub> SUB-TRANSTIME CONST.	0.01s							
T' <sub>do</sub> O.C. FIELD TIME CONST.	2.89s							
T <sub>a</sub> ARMATURE TIME CONST.	0.02s							
SHORT CIRCUIT RATIO	1/X <sub>d</sub>							

**50  
Hz**

**PI734G**  
Winding 312



**THREE PHASE EFFICIENCY CURVES**

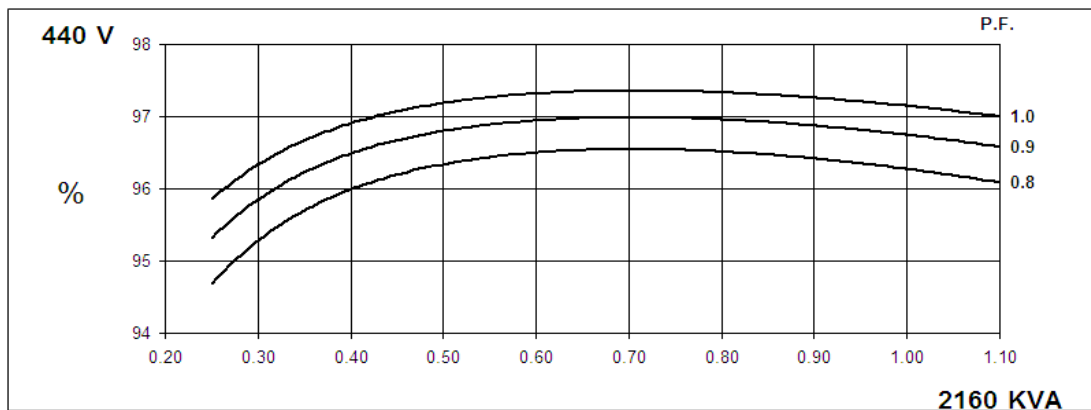
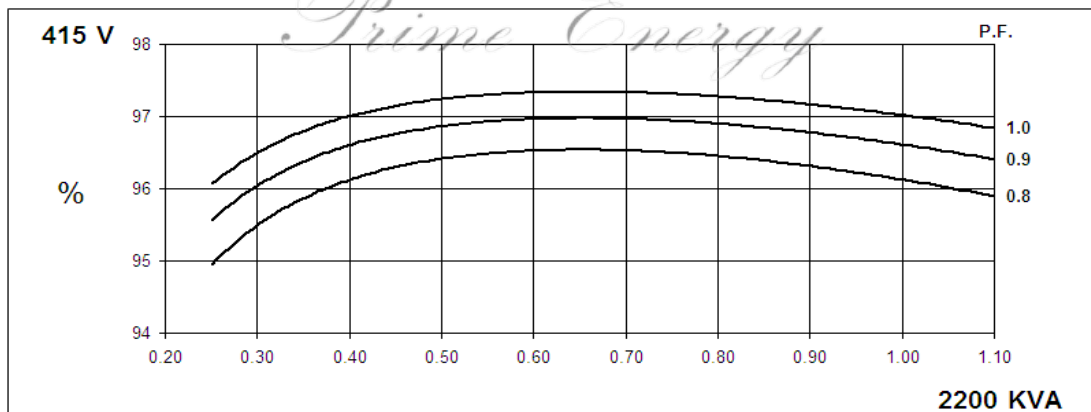
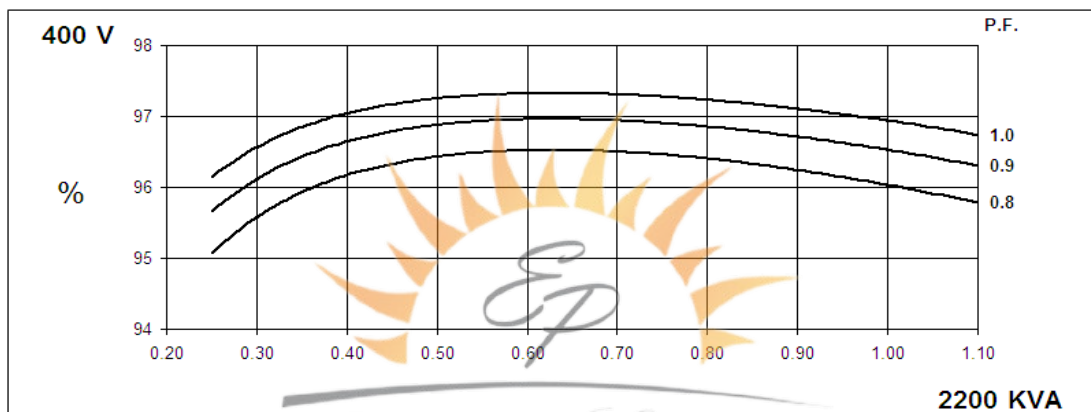
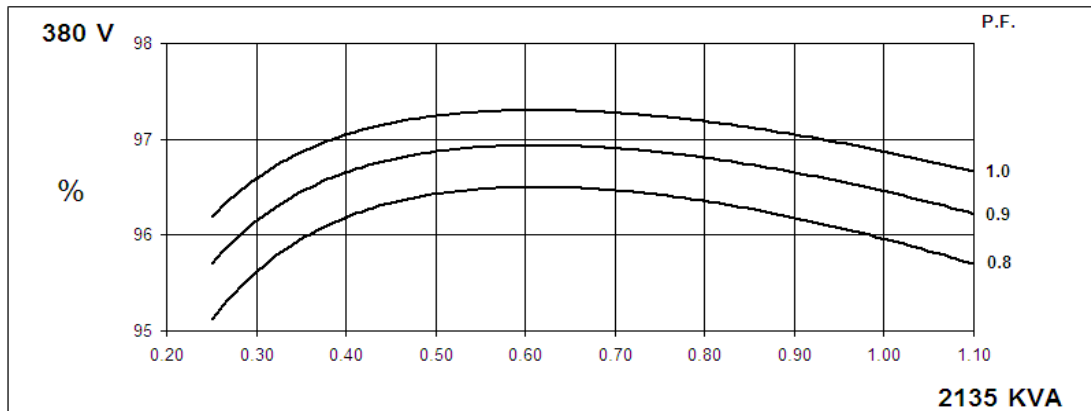

**THREE PHASE EFFICIENCY CURVES**

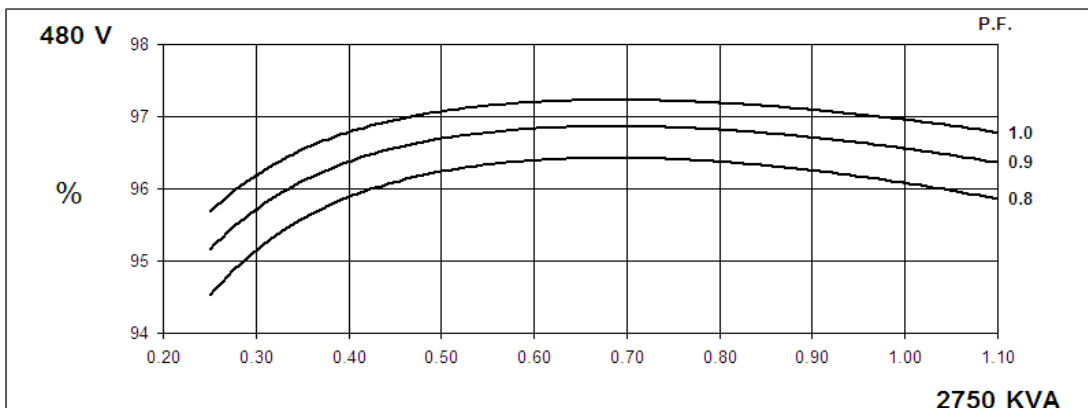
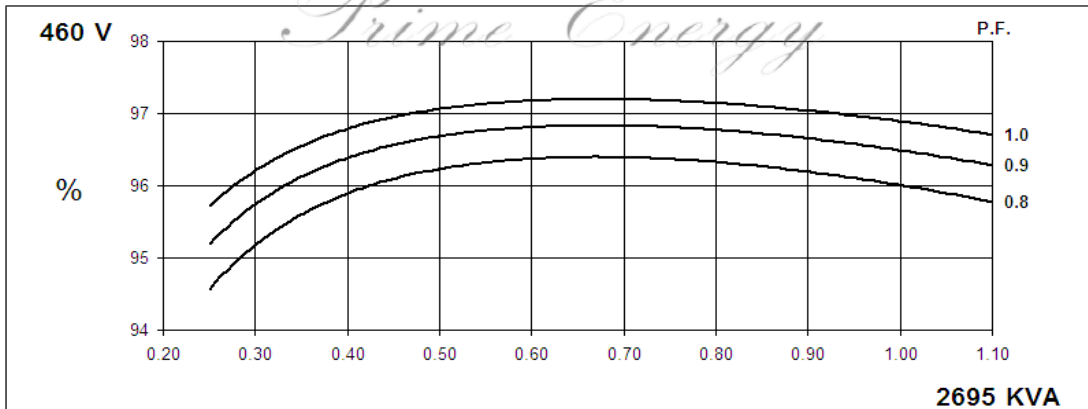
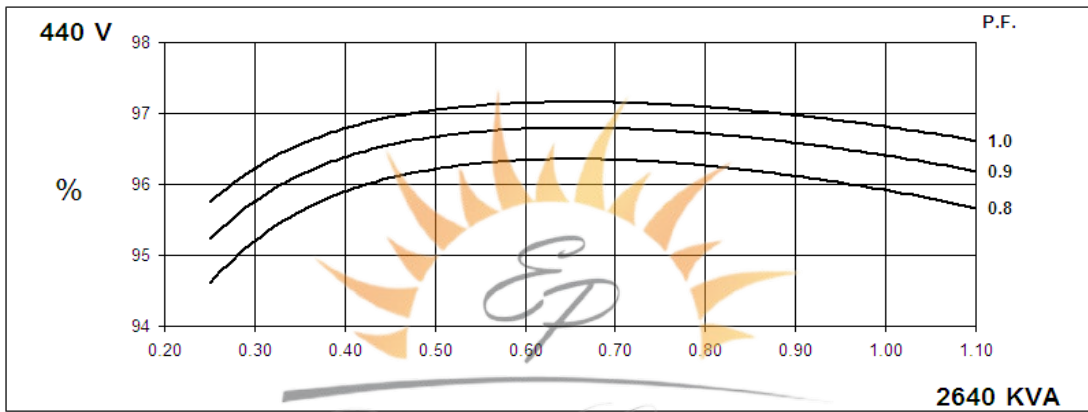
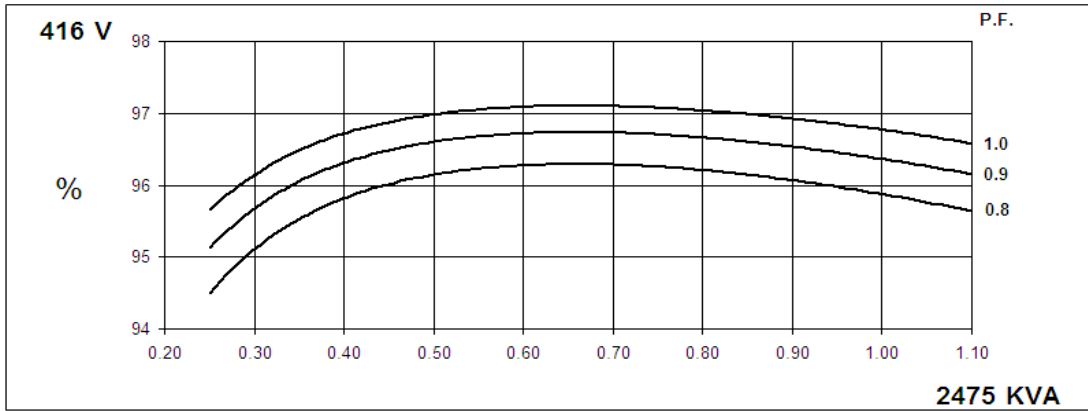

**PI734G**  
Winding 312



**Locked Rotor Motor Starting Curve**

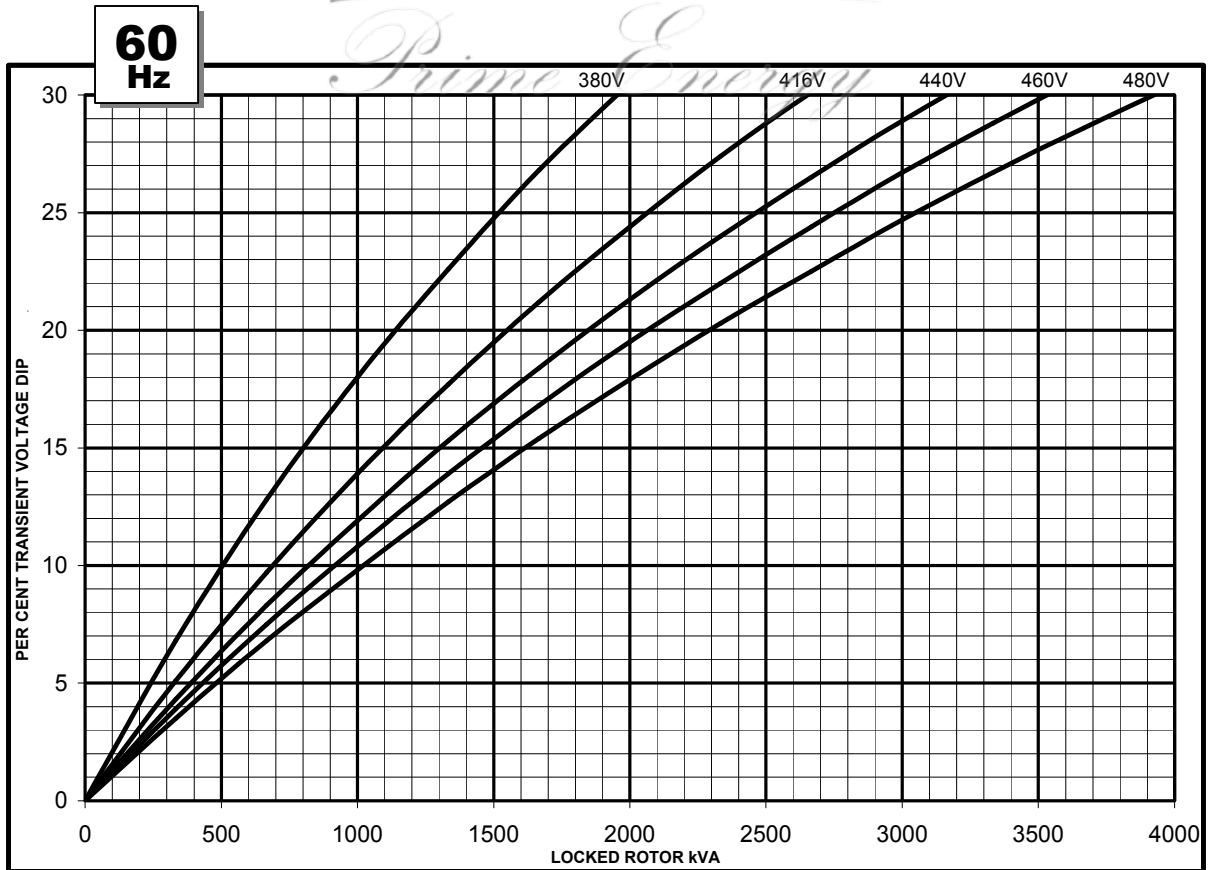
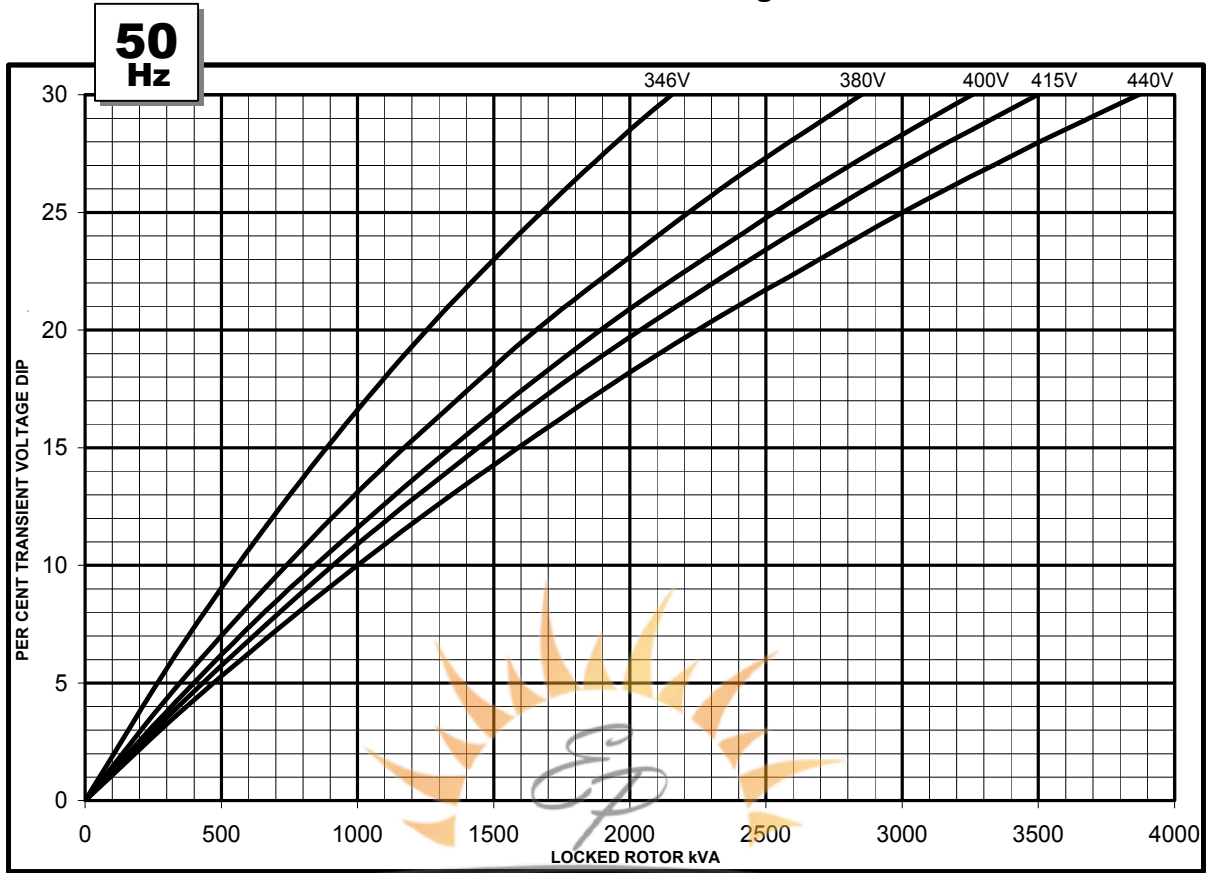

**Three-phase Short Circuit Decrement Curve. No-load Excitation at Rated Speed  
Based on star (wye) connection.**

**50  
Hz**

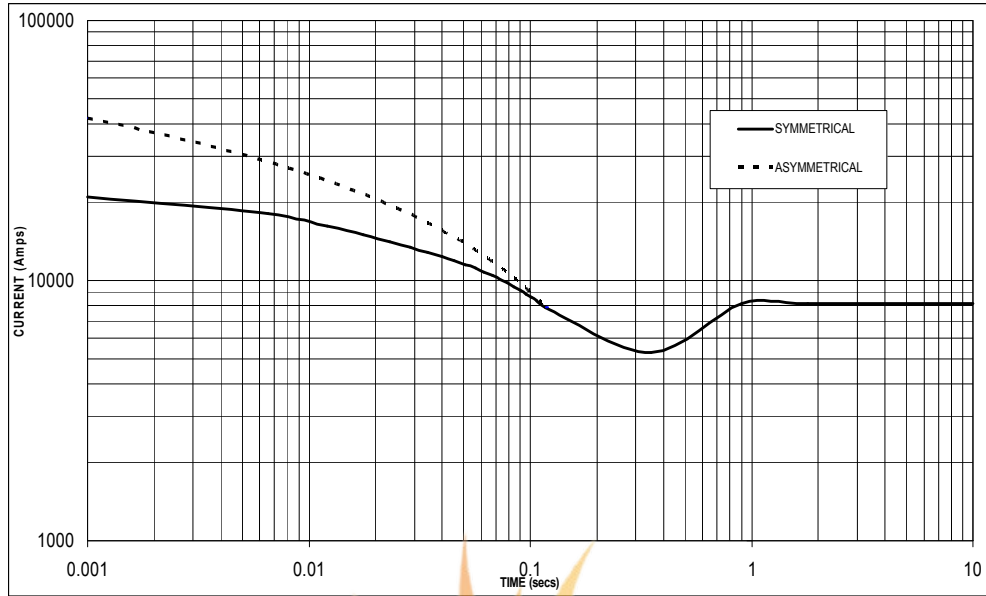

Sustained Short Circuit = 8,150 Amps

**60  
Hz**

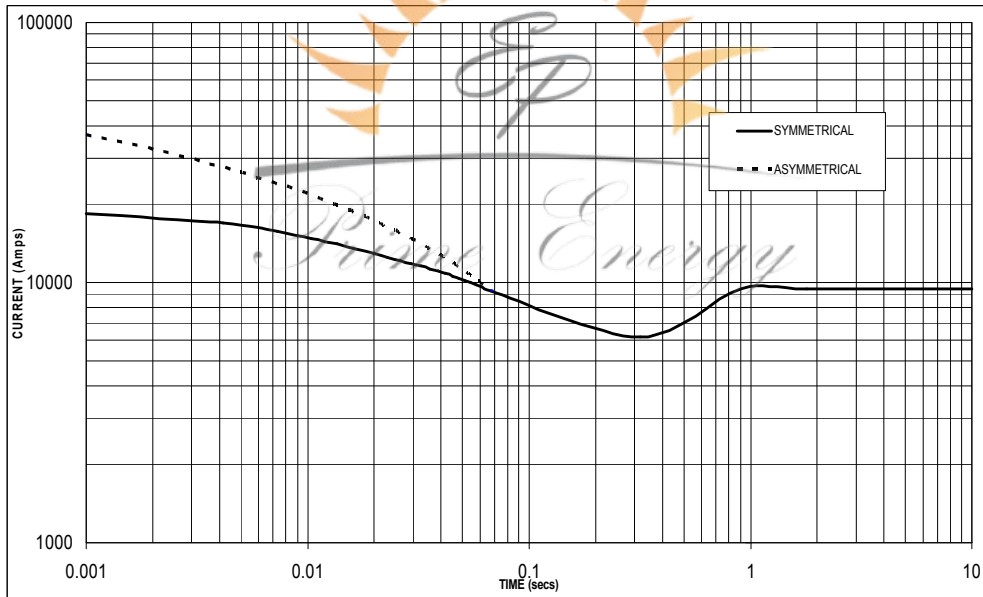

Sustained Short Circuit = 9,500 Amps

**Note 1**

The following multiplication factors should be used to adjust the values from curve between time 0.001 seconds and the minimum current point in respect of nominal operating voltage :

50Hz		60Hz	
Voltage	Factor	Voltage	Factor
380v	x 1.00	416v	x 1.00
400v	x 1.05	440v	x 1.06
415v	x 1.09	460v	x 1.10
440v	x 1.16	480v	x 1.15

The sustained current value is constant irrespective of voltage level

**Note 2**

The following multiplication factor should be used to convert the values calculated in accordance with NOTE 1 to those applicable to the various types of short circuit :

	3-phase	2-phase L-L	1-phase L-N
Instantaneous	x 1.00	x 0.87	x 1.30
Minimum	x 1.00	x 1.80	x 3.20
Sustained	x 1.00	x 1.50	x 2.50
Max. sustained duration	10 sec.	5 sec.	2 sec.

All other times are unchanged

**Note 3**

Curves are drawn for Star (Wye) connected machines.

# PI734G

## Winding 312 / 0.8 Power Factor



### RATINGS

Class - Temp Rise		Cont. F - 105/40°C				Cont. H - 125/40°C				Standby - 150/40°C				Standby - 163/27°C			
<b>50Hz</b>	Star (V)	380	400	415	440	380	400	415	440	380	400	415	440	380	400	415	440
	kVA	1985	2050	2050	2005	2135	2200	2200	2160	2225	2295	2295	2250	2290	2360	2360	2310
	kW	1588	1640	1640	1604	1708	1760	1760	1728	1780	1836	1836	1800	1832	1888	1888	1848
	Efficiency (%)	96.1	96.2	96.3	96.4	96.0	96.0	96.1	96.3	95.9	95.9	96.0	96.2	95.8	95.9	96.0	96.1
	kW Input	1652	1705	1703	1664	1779	1833	1831	1794	1856	1914	1913	1871	1912	1969	1967	1923

<b>60Hz</b>	Star (V)	416	440	460	480	416	440	460	480	416	440	460	480	416	440	460	480
	kVA	2305	2455	2510	2560	2475	2640	2695	2750	2575	2750	2805	2860	2650	2825	2885	2945
	kW	1844	1964	2008	2048	1980	2112	2156	2200	2060	2200	2244	2288	2120	2260	2308	2356
	Efficiency (%)	96.0	96.1	96.1	96.2	95.9	95.9	96.0	96.1	95.8	95.8	95.9	96.0	95.7	95.7	95.8	95.9
	kW Input	1921	2044	2089	2129	2065	2202	2246	2289	2150	2296	2340	2383	2215	2362	2409	2457

### DIMENSIONS

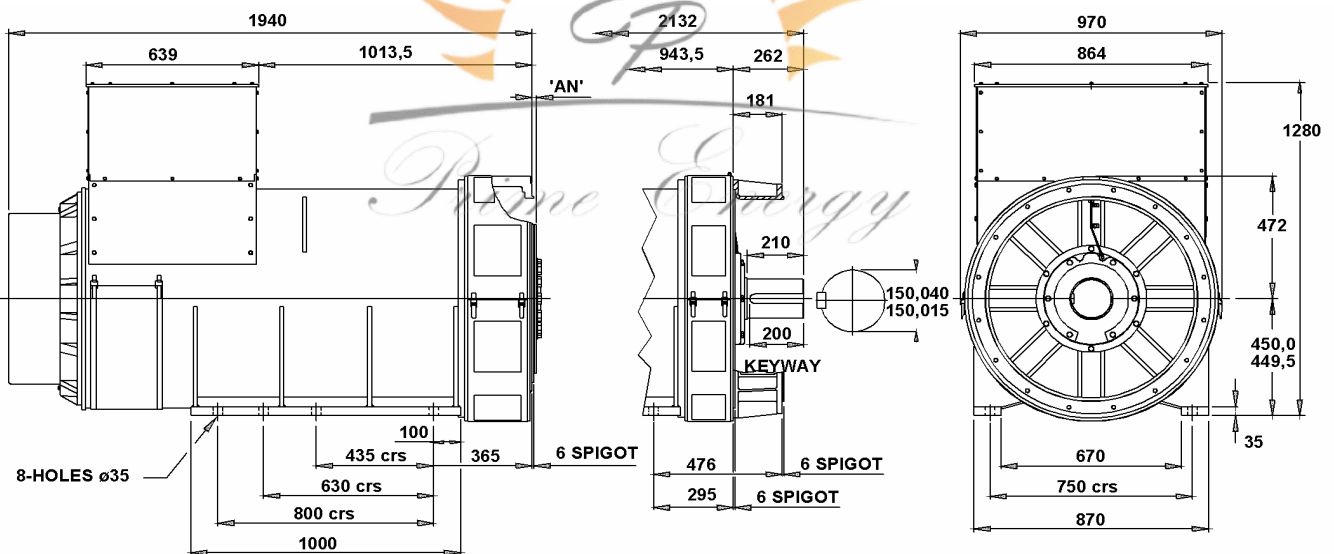

COUPLING DISC	'AN'
S.A.E No 21	0
S.A.E No 24	0

1-BRG ADAPTORS
S.A.E No 0
S.A.E No 00

2-BRG ADAPTORS
S.A.E No 0
S.A.E No 00



Barnack Road • Stamford • Lincolnshire • PE9 2NB  
 Tel: 00 44 (0)1780 484000 • Fax: 00 44 (0)1780 484100  
 Website: [www.newage-avkseg.com](http://www.newage-avkseg.com)