

STAMFORD[®]

PI734F - Technical Data Sheet

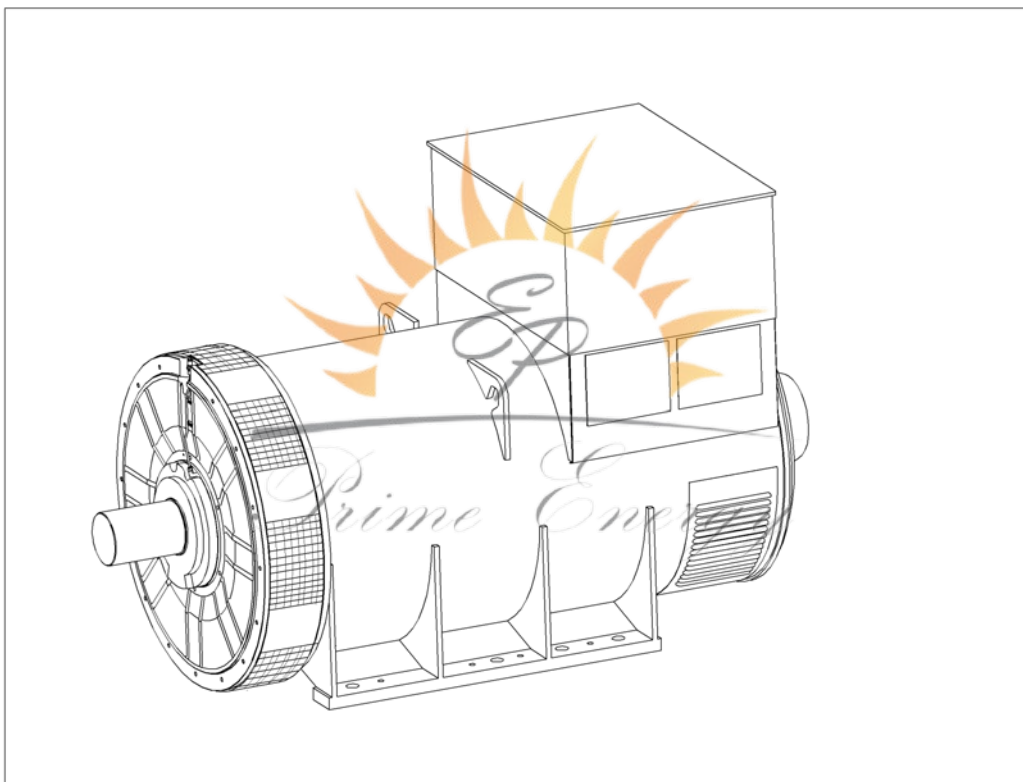

SPECIFICATIONS & OPTIONS

STANDARDS

Newage Stamford industrial generators meet the requirements of BS EN 60034 and the relevant sections of other national and international standards such as BS5000, VDE 0530, NEMA MG1-32, IEC60034, CSA C22.2-100, AS1359.

Other standards and certifications can be considered on request.

DESCRIPTION

The STAMFORD PI range of synchronous ac generators are brushless with a rotating field. They are separately excited by the STAMFORD Permanent Magnet Generator (PMG). This is a shaft mounted, high frequency, pilot exciter which provides a constant supply of clean power via the Automatic Voltage Regulator (AVR) to the main exciter. The main exciter output is fed to the main rotor, through a full wave bridge rectifier, protected by surge suppression.

VOLTAGE REGULATORS

The PI range generators, complete with a PMG, are available with one of two AVRs. Each AVR has soft start voltage build up and built in protection against sustained over-excitation, which will de-excite the generator after a minimum of 8 seconds.

Underspeed protection (UFRO) is also provided on both AVRs. The UFRO will reduce the generator output voltage proportional to the speed of the generator below a pre-settable level.

The **MX341 AVR** is two phase sensed with a voltage regulation of $\pm 1\%$. (see the note on regulation).

The **MX321 AVR** is 3 phase rms sensed with a voltage regulation of 0.5% rms (see the note on regulation). The UFRO circuit has adjustable slope and dwell for controlled recovery from step loads. An over voltage protection circuit will shutdown the output device of the AVR, it can also trip an optional excitation circuit breaker if required. As an option, short circuit current limiting is available with the addition of current transformers.

Both the MX341 and the MX321 need a generator mounted current transformer to provide quadrature droop characteristics for load sharing during parallel operation. Provision is also made for the connection of the STAMFORD power factor controller, for embedded applications, and a remote voltage trimmer.

WINDINGS & ELECTRICAL PERFORMANCE

All generator stators are wound to 2/3 pitch. This eliminates triplen (3rd, 9th, 15th ...) harmonics on the voltage waveform and is found to be the optimum design for trouble-free supply of non-linear loads. The 2/3 pitch design avoids excessive neutral currents sometimes seen with higher winding pitches. A fully connected damper winding reduces oscillations during paralleling. This winding, with the 2/3 pitch and carefully selected pole and tooth designs, ensures very low levels of voltage waveform distortion.

TERMINALS & TERMINAL BOX

Standard generators feature a main stator with 6 ends brought out to the terminals, which are mounted on the frame at the non-drive end of the generator. A sheet steel terminal box contains the AVR and provides ample space for the customers' wiring and gland arrangements. It has removable panels for easy access.

SHAFT & KEYS

All generator rotors are dynamically balanced to better than BS6861:Part 1 Grade 2.5 for minimum vibration in operation. Two bearing generators are balanced with a half key.

INSULATION/IMPREGNATION

The insulation system is class 'H', and meets the requirements of UL1446.

All wound components are impregnated with materials and processes designed specifically to provide the high build required for static windings and the high mechanical strength required for rotating components.

QUALITY ASSURANCE

Generators are manufactured using production procedures having a quality assurance level to BS EN ISO 9001.

NOTE ON REGULATION

The stated voltage regulation may not be maintained in the presence of certain radio transmitted signals. Any change in performance will fall within the limits of Criteria 'B' of EN 61000-6-2:2001. At no time will the steady-state voltage regulation exceed 2%.

Note: Continuous development of our products entitles us to change specification details without notice, therefore they must not be regarded as binding.

Front cover drawing is typical of the product range.

PI734F WINDING 312

STAMFORD

CONTROL SYSTEM	SEPARATELY EXCITED BY P.M.G.		
A.V.R.	MX341	MX321	
VOLTAGE REGULATION	± 1%	± 0.5 %	With 4% ENGINE GOVERNING
SUSTAINED SHORT CIRCUIT	REFER TO SHORT CIRCUIT DECREMENT CURVES (page 7)		

INSULATION SYSTEM	CLASS H							
PROTECTION	IP23							
RATED POWER FACTOR	0.8							
STATOR WINDING	DOUBLE LAYER LAP							
WINDING PITCH	TWO THIRDS							
WINDING LEADS	6							
MAIN STATOR RESISTANCE	0.00076 Ohms PER PHASE AT 22°C STAR CONNECTED							
MAIN ROTOR RESISTANCE	2.31 Ohms at 22°C							
EXCITER STATOR RESISTANCE	17.5 Ohms at 22°C							
EXCITER ROTOR RESISTANCE	0.063 Ohms PER PHASE AT 22°C							
R.F.I. SUPPRESSION	BS EN 61000-6-2 & BS EN 61000-6-4, VDE 0875G, VDE 0875N. refer to factory for others							
WAVEFORM DISTORTION	NO LOAD < 1.5% NON-DISTORTING BALANCED LINEAR LOAD < 5.0%							
MAXIMUM OVERSPEED	2250 Rev/Min							
BEARING DRIVE END	BALL. 6232 C3							
BEARING NON-DRIVE END	BALL. 6319 C3							
	1 BEARING			2 BEARING				
WEIGHT COMP. GENERATOR	3840 kg			3807 kg				
WEIGHT WOUND STATOR	1908 kg			1908 kg				
WEIGHT WOUND ROTOR	1609 kg			1565 kg				
WR ² INERTIA	49.3409 kgm ²			48.424 kgm ²				
SHIPPING WEIGHTS in a crate	3913kg			3876kg				
PACKING CRATE SIZE	216 x 105 x 154(cm)			216 x 105 x 154(cm)				
	50 Hz			60 Hz				
TELEPHONE INTERFERENCE	THF<2%			TIF<50				
COOLING AIR	2.69 m ³ /sec 5700 cfm			3.45 m ³ /sec 7300 cfm				
VOLTAGE STAR	380/220	400/231	415/240	440/254	416/240	440/254	460/266	480/277
kVA BASE RATING FOR REACTANCE VALUES	2020	2080	2080	2040	2340	2500	2550	2600
X _d DIR. AXIS SYNCHRONOUS	2.93	2.73	2.53	2.21	3.54	3.38	3.16	2.96
X' _d DIR. AXIS TRANSIENT	0.18	0.17	0.15	0.13	0.21	0.20	0.19	0.18
X'' _d DIR. AXIS SUBTRANSIENT	0.13	0.12	0.11	0.10	0.16	0.15	0.14	0.13
X _q QUAD. AXIS REACTANCE	1.89	1.75	1.63	1.42	2.28	2.18	2.03	1.90
X'' _q QUAD. AXIS SUBTRANSIENT	0.26	0.25	0.23	0.20	0.32	0.31	0.29	0.27
X _L LEAKAGE REACTANCE	0.03	0.03	0.03	0.03	0.04	0.04	0.04	0.03
X ₂ NEGATIVE SEQUENCE	0.19	0.17	0.16	0.14	0.23	0.22	0.20	0.19
X ₀ ZERO SEQUENCE	0.02	0.02	0.02	0.02	0.03	0.03	0.02	0.02
REACTANCES ARE SATURATED				VALUES ARE PER UNIT AT RATING AND VOLTAGE INDICATED				
T' _d TRANSIENT TIME CONST.	0.154s							
T'' _d SUB-TRANSTIME CONST.	0.02s							
T' _{do} O.C. FIELD TIME CONST.	2.54s							
T _a ARMATURE TIME CONST.	0.02s							
SHORT CIRCUIT RATIO	1/X _d							

50
Hz

PI734F
Winding 312

STAMFORD

THREE PHASE EFFICIENCY CURVES

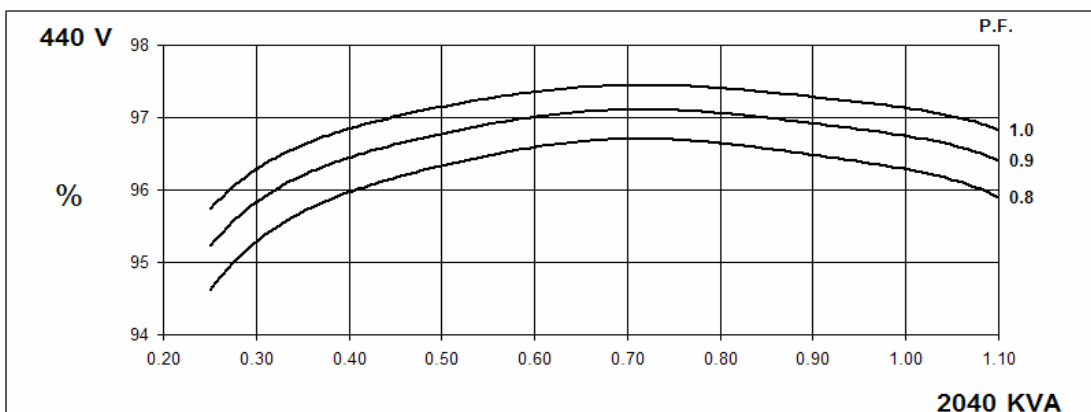
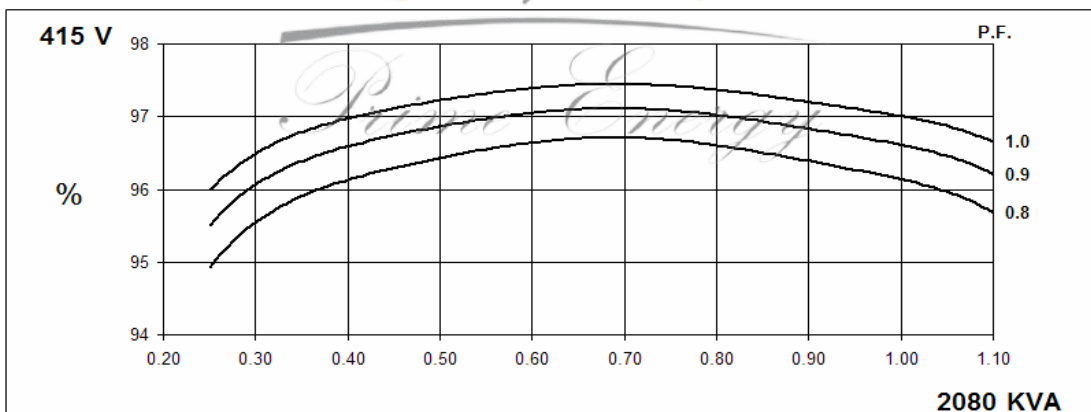
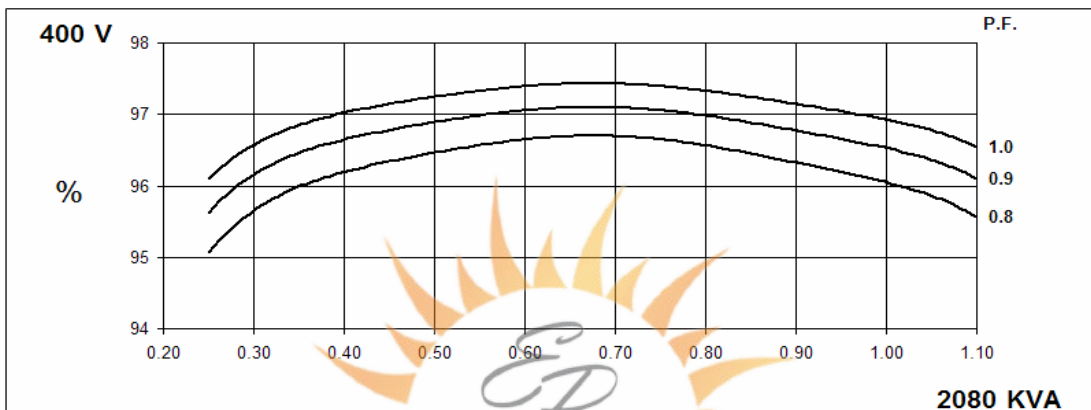
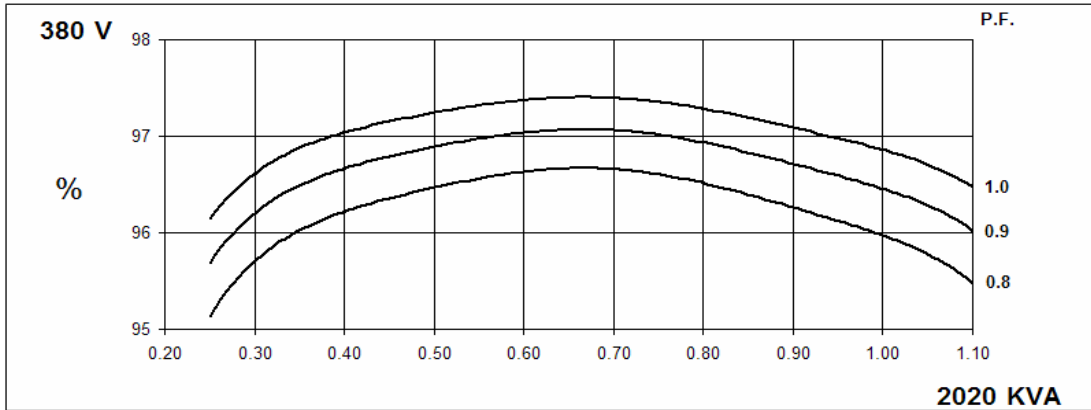

60
Hz

PI734F
Winding 312

STAMFORD

THREE PHASE EFFICIENCY CURVES

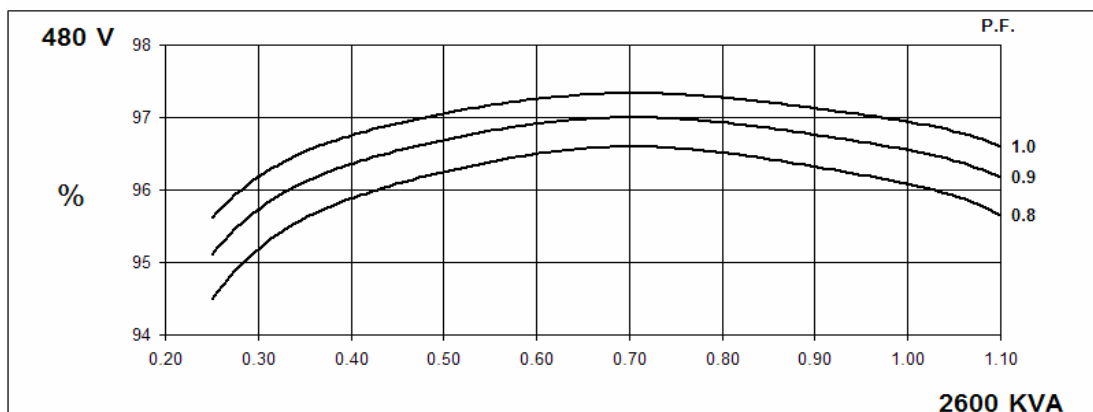
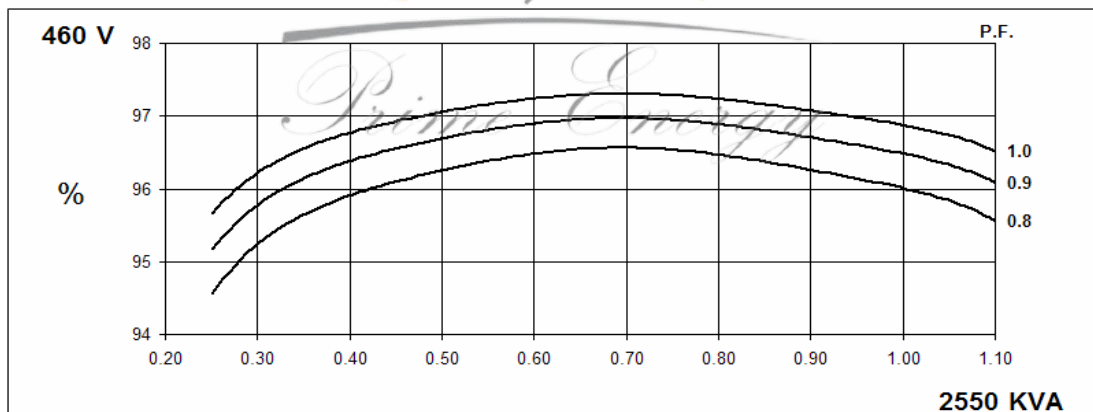
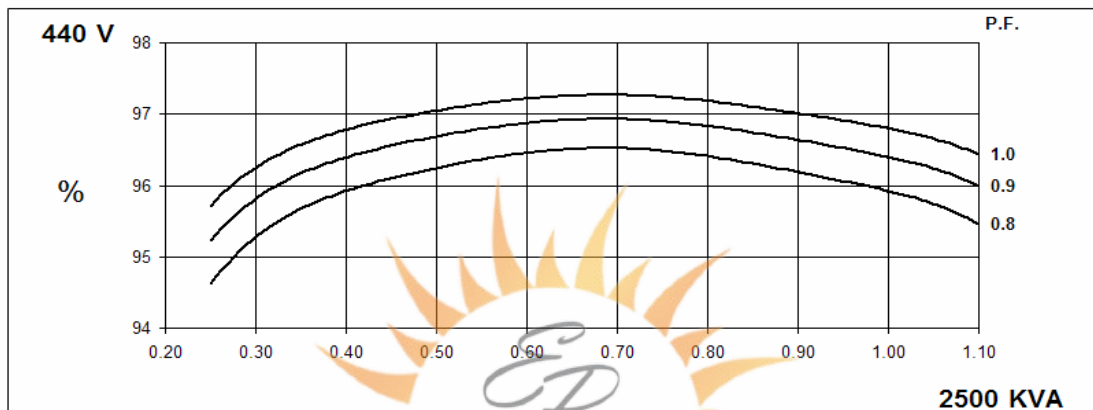
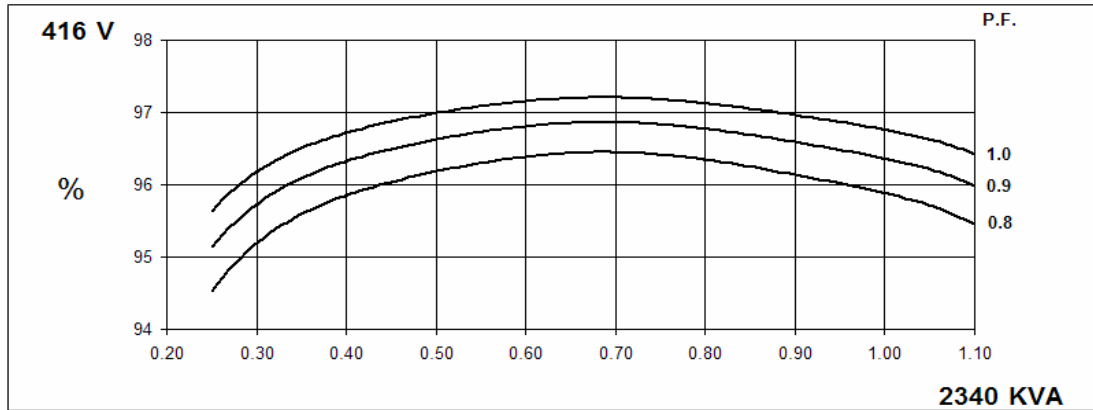

PI734F
Winding 312

STAMFORD

Locked Rotor Motor Starting Curve

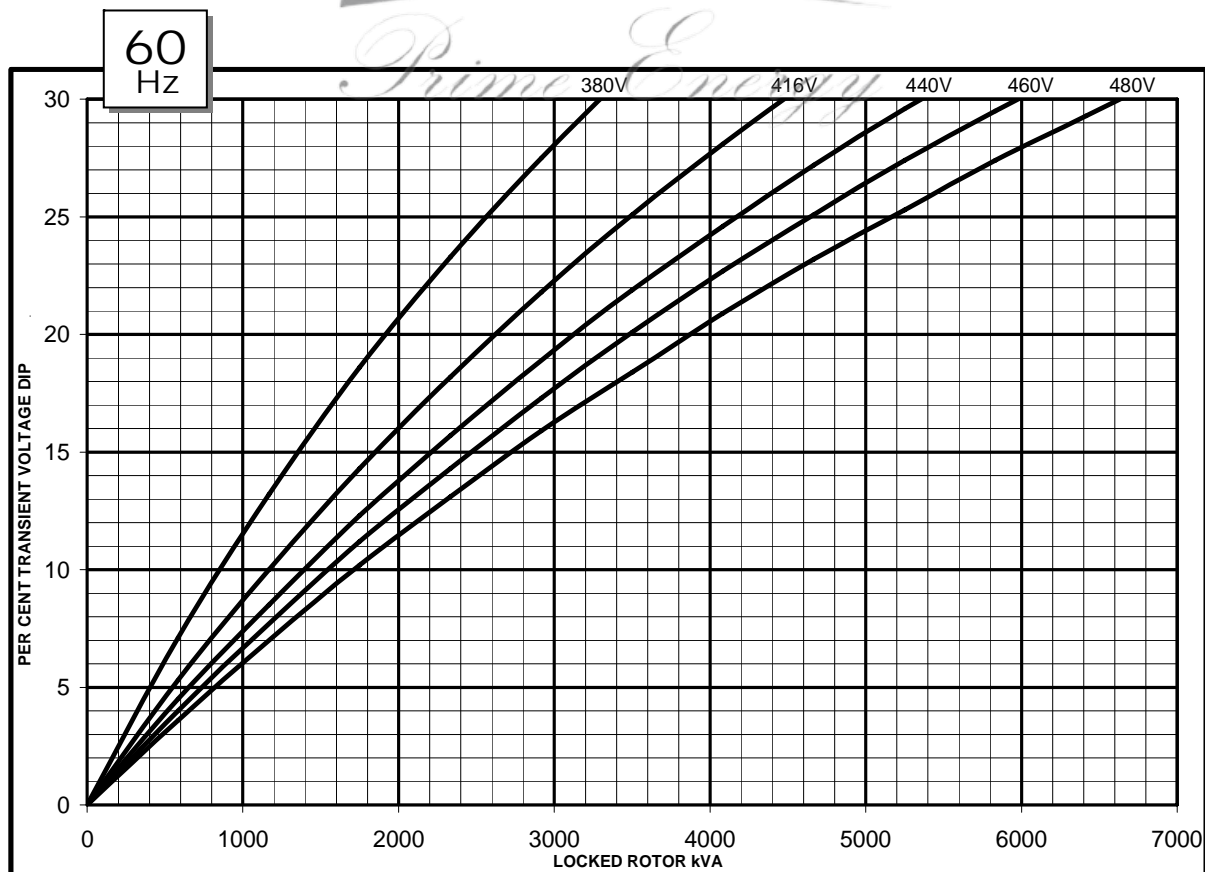
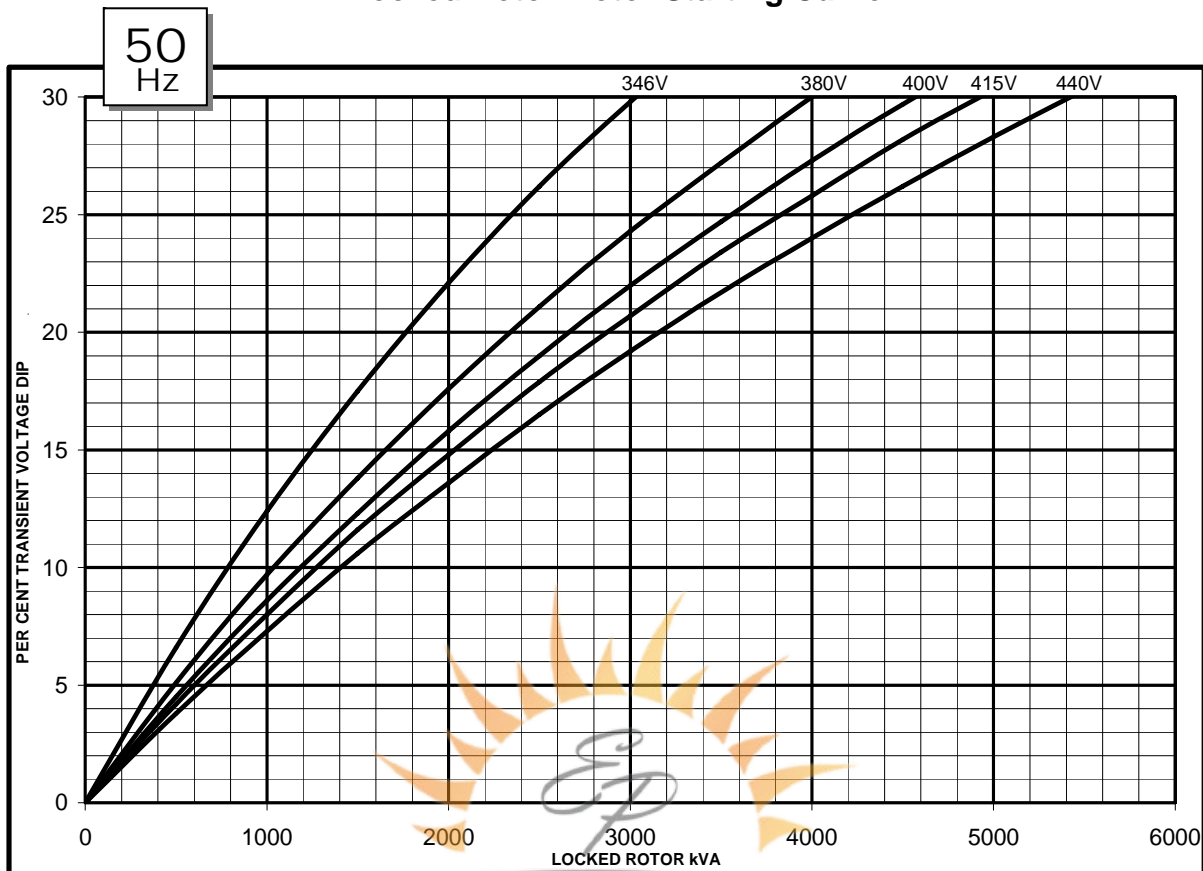

**Three-phase Short Circuit Decrement Curve. No-load Excitation at Rated Speed
Based on star (wye) connection.**

50
Hz

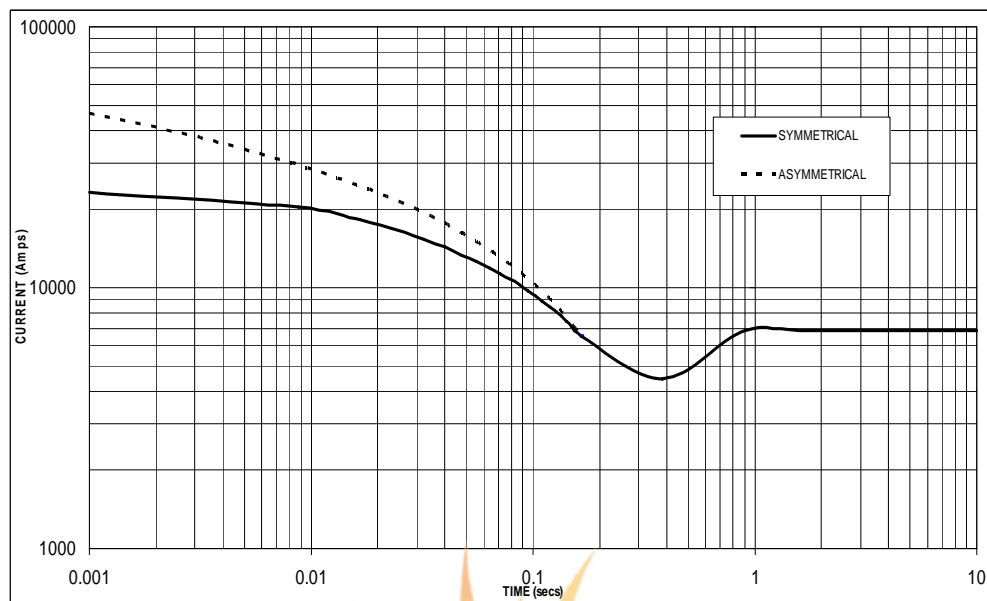

Sustained Short Circuit = 6,850 Amps

60
Hz

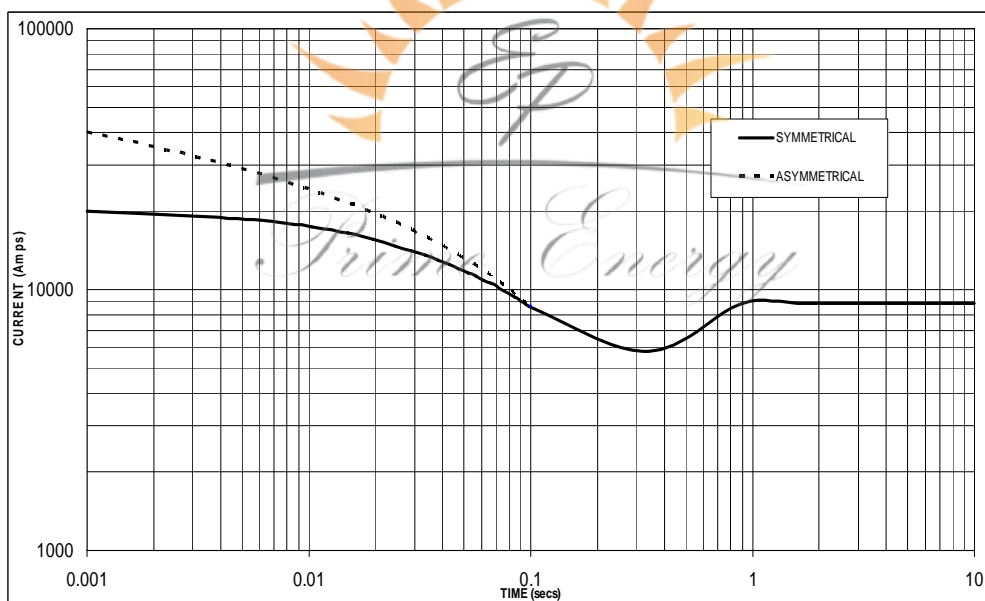

Sustained Short Circuit = 8,900 Amps

Note 1

The following multiplication factors should be used to adjust the values from curve between time 0.001 seconds and the minimum current point in respect of nominal operating voltage :

50Hz		60Hz	
Voltage	Factor	Voltage	Factor
380v	x 1.00	416v	x 1.00
400v	x 1.05	440v	x 1.06
415v	x 1.09	460v	x 1.10
440v	x 1.16	480v	x 1.15

The sustained current value is constant irrespective of voltage level

Note 2

The following multiplication factor should be used to convert the values calculated in accordance with NOTE 1 to those applicable to the various types of short circuit :

	3-phase	2-phase L-L	1-phase L-N
Instantaneous	x 1.00	x 0.87	x 1.30
Minimum	x 1.00	x 1.80	x 3.20
Sustained	x 1.00	x 1.50	x 2.50
Max. sustained duration	10 sec.	5 sec.	2 sec.

All other times are unchanged

Note 3

Curves are drawn for Star (Wye) connected machines.

PI734F
Winding 312 / 0.8 Power Factor

RATINGS

Class - Temp Rise		Cont. F - 105/40°C				Cont. H - 125/40°C				Standby - 150/40°C				Standby - 163/27°C			
50Hz	Star (V)	380	400	415	440	380	400	415	440	380	400	415	440	380	400	415	440
	kVA	1880	1935	1935	1900	2020	2080	2080	2040	2105	2170	2170	2125	2165	2230	2230	2185
	kW	1504	1548	1548	1520	1616	1664	1664	1632	1684	1736	1736	1700	1732	1784	1784	1748
	Efficiency (%)	96.1	96.2	96.3	96.4	96.0	96.0	96.1	96.3	95.9	95.9	96.0	96.2	95.8	95.9	96.0	96.2
	kW Input	1565	1609	1607	1577	1683	1733	1732	1695	1756	1810	1808	1767	1808	1860	1858	1817

60Hz	Star (V)	416	440	460	480	416	440	460	480	416	440	460	480	416	440	460	480
	kVA	2180	2325	2370	2420	2340	2500	2550	2600	2435	2600	2650	2705	2505	2675	2730	2785
	kW	1744	1860	1896	1936	1872	2000	2040	2080	1948	2080	2120	2164	2004	2140	2184	2228
	Efficiency (%)	96.0	96.1	96.1	96.2	95.9	95.9	96.0	96.1	95.8	95.8	95.9	96.0	95.7	95.8	95.9	95.9
	kW Input	1817	1935	1973	2012	1952	2086	2125	2164	2033	2171	2211	2254	2094	2234	2277	2323

DIMENSIONS

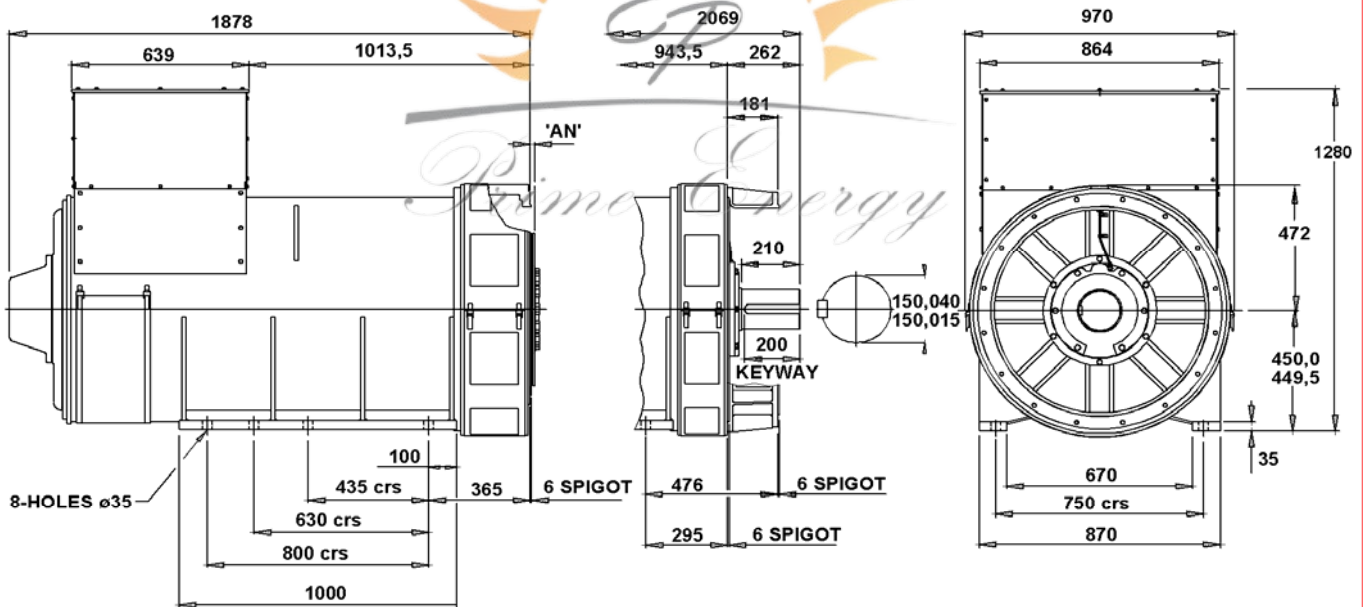

COUPLING DISC	'AN'
S.A.E No 18	15,7
S.A.E No 21	0
S.A.E No 24	0

1-BRG ADAPTORS
S.A.E No 0
S.A.E No 00

2-BRG ADAPTORS
S.A.E No 0
S.A.E No 00